

H
U
O
O
R
O
O
D

Clight

www.clight-led.com



Surface mounted wall light.



Surface mounted ceiling light.



Recessed wall light.



In-ground floor light.



In-ground pole light.



Light direction: Single



Light direction: Double



Light direction: All



Lens angle.



The product complies with EU safety, health, and environmental protection standards.



'Earth Ground' – denotes the point of zero voltage or safety grounding.



Protected against limited dust ingress and water spray from any direction.



Dust-tight and protected against low-pressure water jets from any angle.



Completely dust-tight and protected against temporary immersion in water.

OUT
DOOR

WALL

4

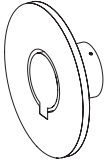

6

8

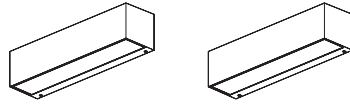

ANTRO

DELLA

| UP/DOWN

10

12

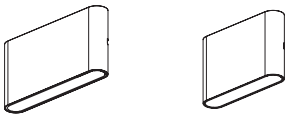

14

16

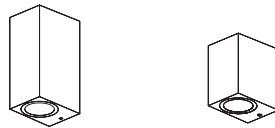

FLATO

| mini

RIO

| mini

e27 WALL

18

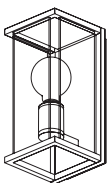

ESTRA

CEILING

20



MARS 18W | **30W**

PATH

22

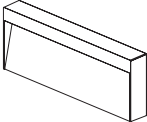

24



26

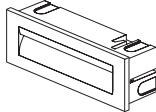

MODO | **mini**

VEGA

POLE

28



30



32

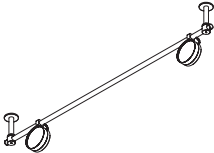

STICK | **short**

| **wall**

INGROUND

34

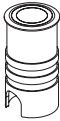

FLORA



ANTRO

Modern sophistication meets precise functionality in this versatile wall light, designed for outdoor settings but equally suitable for indoor use. Its adjustable circular lampshade offers a unique 90° rotation, enabling targeted illumination. Crafted with meticulous attention to detail, this luminaire ensures a precise and consistent beam of light, enhancing the ambiance of any space, whether outside or within the comfort of your home.

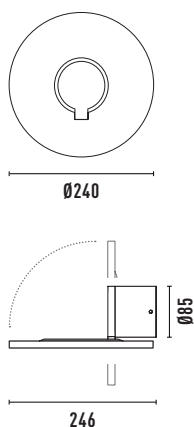



W	°K	Lm	Optics	CRI	Protection
8	3000	500	99°	≥80	IP54

CARTON

dim. L46*W30.5*H31cm
 cbm 0.043
 pcs. 4
 net w. 3.78kg
 gross w. 6.26kg

FINISHES / SKU

Black	White	Graphite
		
15539	15540	15541

FEATURES

- Features a movement system enabling a full 90° rotation.
- Die-cast aluminum body.
- LED light source included.
- Equipped with double cable gland for electrical connection.





DELLA

Crafted from die-cast aluminum, this luminaire epitomizes durability for outdoor settings. Featuring an frosted glass diffuser, it promises a gentle and even luminosity. Integrating advanced LED technology with a polished design, Della gracefully complements any outdoor space, offering both resilience and unparalleled aesthetic allure.

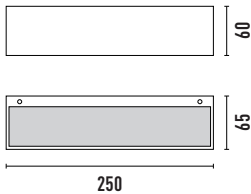





W	°K	Lm	Optics	CRI	Protection
7	3000	668	110°	≥80	IP65

CARTON

dim. L37.5*W19.5*H31.5cm
 cbm 0.023
 pcs. 8
 net w. 9kg
 gross w. 10.5kg

FINISHES / SKU

Black	White	Graphite
		
15545	15546	15547
Wood	Stone	
		
15548	15549	

FEATURES

- Die-cast aluminum body.
- Crafted with high-quality, frosted glass.
- LED light source included.
- Equipped with double cable gland for electrical connection.





DELLA UP/DOWN

Offering captivating dual-directional illumination, this outdoor wall light enhances any exterior setting. Boasting an IP65 protection rating, it stands resilient against diverse weather conditions. Crafted from durable die-cast aluminum, the luminaire seamlessly combines lasting durability with modern elegance.

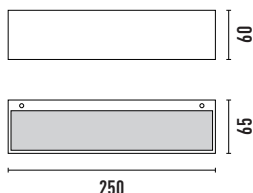



W	°K	Lm	Optics	CRI	Protection
14	3000	1140	110°	≥80	IP65

CARTON

dim. L37.5*W19.5*H31.5cm
 cbm 0.023
 pcs. 8
 net w. 8.8kg
 gross w. 10.6kg

FINISHES / SKU

Black	White	Graphite
		
15542	15543	15544

FEATURES

- Die-cast aluminum body.
- Crafted with high-quality, frosted glass.
- LED light source included.
- Equipped with double cable gland for electrical connection.





FLATO

Crafted for sophistication and durability, this dual-emission LED wall luminaire showcases a premium aluminum finish, complemented by an IP65 rating for robust dust and water resistance. Designed for technical efficiency, it offers straightforward screw-fixed mounting to any wall.

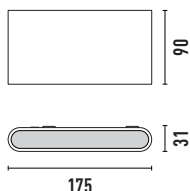



W	°K	Lm	Optics	CRI	Protection
10	3000	950	-	≥80	IP65

CARTON

dim. L41.5*W39*H20cm
cbm 0.032
pcs. 18
net w. 10.3kg
gross w. 10.46kg

FINISHES / SKU

White	Black
	
15512	15513

FEATURES

- Die-cast aluminum body.
- Crafted with high-quality, frosted glass.
- LED light source included.
- Equipped with double cable gland for electrical connection.





FLATO mini

Presenting a compact, dual-emission LED wall luminaire, this minimalist design is defined by its superior aluminum finish and IP65 certification, ensuring dust and water resistance. Its installation is streamlined with a simple, screw-fixed method suitable for various wall surfaces.

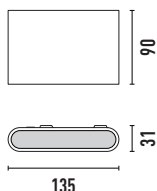



W	°K	Lm	Optics	CRI	Protection
6	3000	540	-	≥80	IP65

CARTON

dim. L39*W33.5*H20cm
cbm 0.026
pcs. 18
net w. 8.46kg
gross w. 12.66kg

FINISHES / SKU

White	Black
	
15510	15511

FEATURES

- Die-cast aluminum body.
- Crafted with high-quality, frosted glass.
- LED light source included.
- Equipped with double cable gland for electrical connection.





RIO

Featuring a cuboid shape that elegantly emits light from both ends, this surface light is ideal for lighting entrances, terraces, or garages. Its durable aluminum construction, complete with IP54 protection, ensures durability. Available in various wood or stone finishes, it seamlessly complements any outdoor environment.

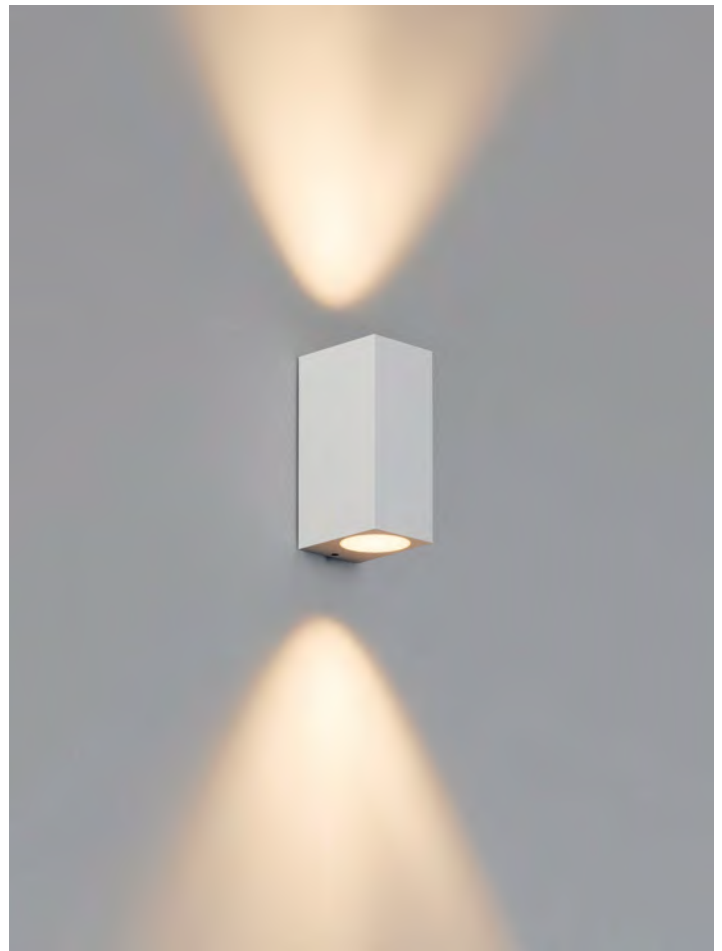
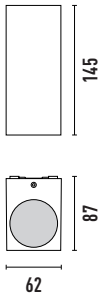

W	°K	Lm	Optics	CRI	Protection
14	3000	1365	73°	≥80	IP54

CARTON

dim. L33.5*W19.5*H23cm

cbm 0.015

pcs. 12

net w. 9.3kg (15521/15522/15523)

11.4kg (15524/15525)

gross w. 10.1kg (15521/15522/15523)

12.5kg (15524/15525)

FINISHES / SKU

Black



15521

White



15522

Graphite



15523

Wood



15524

Stone



15525



FEATURES

- Die-cast aluminum body.
- Crafted with high-quality, frosted glass.
- LED light source included.
- Equipped with double cable gland for electrical connection.



RIO mini

Capturing the essence of its larger version, the RIO MINI surface light, designed in a sleek cuboid shape, emits light downward, creating an ambient and safe environment. Ideal for entrances, terraces, or garage facades, this fixture is encased in durable aluminum and boasts IP54 protection, guaranteeing resilience against various weather conditions.

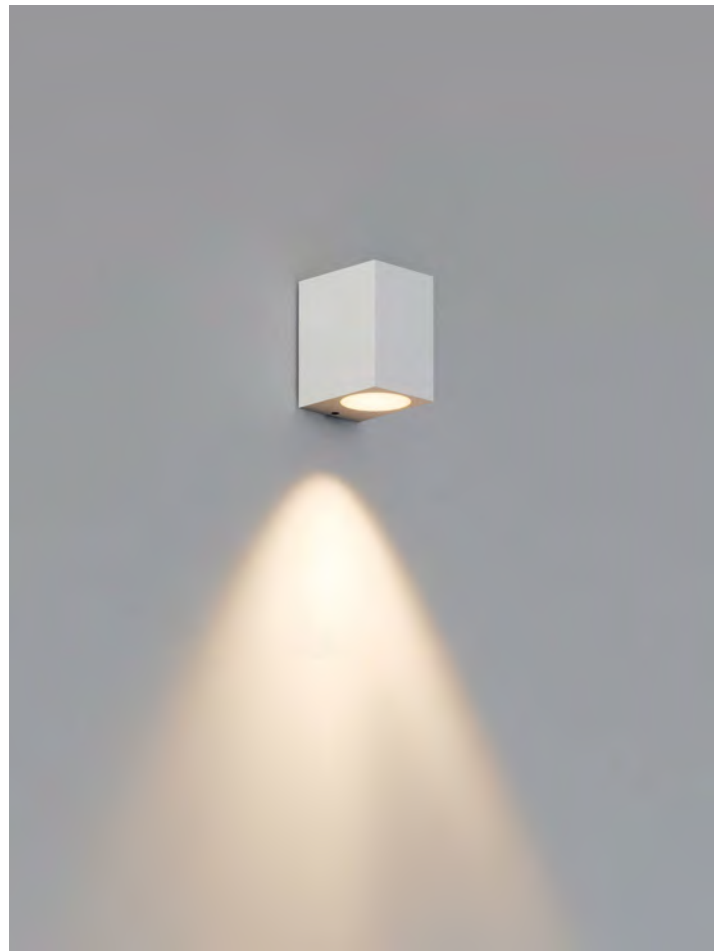
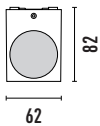
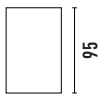



W	°K	Lm	Optics	CRI	Protection
7	3000	577	72°	≥80	IP54

CARTON

dim. L28.5*W22.5*H24cm
cbm 0.015
pcs. 18
net w. 10.4kg
gross w. 12kg

FINISHES / SKU

Black	White	Graphite
		
15526	15527	15528

FEATURES

- Die-cast aluminum body.
- Crafted with high-quality, frosted glass.
- LED light source included.
- Equipped with double cable gland for electrical connection.





ESTRA E27

With a focus on the illuminant, the Estra wall light stands as an eye-catcher due to its simple yet elegant design. Merging sophistication with efficiency, it brightens outdoor spaces with precision. Moreover, its IP54 protection rating ensures that this sleek piece remains resilient against diverse weather conditions, affirming its reliability for outdoor installations.

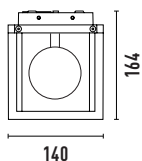
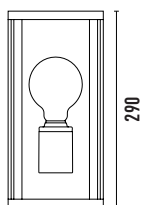

W	°K	Lm	Optics	CRI	Protection
E27 max 15W	-	-	-	-	IP54

CARTON

dim. L38.5*W26.5*H48cm

cbm 0.049

pcs. 2

net w. 4.4kg (15535), 4.91kg (15536)

gross w. 6.2kg (15535), 6.72kg (15536)

FINISHES / SKU

Graphite

Wood



15535

15536

FEATURES

- Die-cast aluminum body.
- Crafted with high-quality, tempered glass.
- Includes an E27 bulb socket (bulb not provided).
- Equipped with double cable gland for electrical connection.





| OUTDOOR | Ceiling Lights |

MARS 18/30W

Featuring a refined design, this surface lamp delivers technical sophistication. Its soft yet effective illumination, complemented by an IP54 rating, renders it ideal for varied environments, indoors or outdoors. Available in two distinct sizes, its adaptable structure ensures seamless integration into any architectural context, providing a blend of functionality and elegance.



18W | 15514/15515

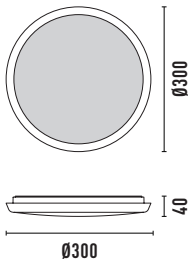

30W | 15516/15517

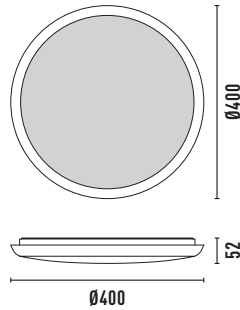

W	°K	Lm	Optics	CRI	Protection
18	3000	1800	120°	≥80	IP54
30	3000	3200	120°	≥80	IP54

CARTON

dim. L53*W31.5*H33cm (15514/15515)
 L63*W41.5*H43cm (15516/15517)
 cbm 0.055 (15514/15515)
 0.112 (15516/15517)
 pcs. 10 (15514/15515/15516/15517)
 net w. 8kg (15514/15515)
 14kg (15516/15517)
 gross w. 10.8kg (15514/15515)
 18.84kg (15516/15517)

FINISHES / SKU

White	Black
15514	15515
White	Black
15516	15517

FEATURES

- Die-cast aluminum body.
- Crafted with high-quality, frosted glass.
- LED light source included.
- Equipped with double cable gland for electrical connection.





MODO

Boasting a minimalist cubic design, this IP65-rated outdoor surface-mounted luminaire integrates energy-efficient LED technology behind a glass diffuser. It casts a gentle yet brilliant light, making it a versatile and decorative element for various outdoor settings.

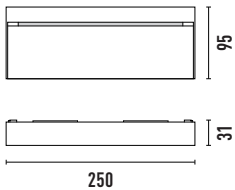



W	°K	Lm	Optics	CRI	Protection
8	3000	593	49°	≥80	IP65

CARTON

dim. L37.5*W26*H29cm
 cbm 0.028
 pcs. 12
 net w. 9.6kg
 gross w. 11.3kg

FINISHES / SKU

Black	White	Graphite
		
15529	15530	15531

FEATURES

- Die-cast aluminum body.
- LED light source included.
- Equipped with double cable gland for electrical connection.





MODO mini

This compact version of the outdoor surface-mounted luminaire features an IP65 rating and a minimalist cubic design. It combines energy-efficient LED technology with a frosted glass diffuser, offering both gentle and brilliant illumination. This makes it a versatile and attractive decorative element for a variety of outdoor areas.

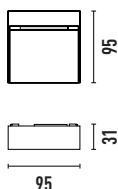



W	°K	Lm	Optics	CRI	Protection
4	3000	154	52°	≥80	IP65

CARTON

dim. L37.5*W19.5*H26cm
cbm 0.019
pcs. 18
net w. 5.6kg
gross w. 7.7kg

FINISHES / SKU

Black	White	Graphite
		
15532	15533	15534

FEATURES

- Die-cast aluminum body.
- LED light source included.
- Equipped with double cable gland for electrical connection.





VEGA

Designed to enhance both aesthetics and safety in walkways, this recessed wall luminaire is ideal for outdoor use, including installation on house facades. Constructed from durable aluminum, it is accompanied by a housing that serves as a mold for concrete installation, seamlessly integrating LED technology for functional elegance.

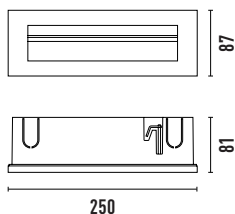



W	°K	Lm	Optics	CRI	Protection
9	3000	198	42°	≥80	IP65

CARTON

dim. L44*W29*H35cm
cbm 0.045
pcs. 12
net w. 8.1kg
gross w. 10.7kg

FINISHES / SKU

White	Graphite
	
15537	15538

FEATURES

- Die-cast aluminum body.
- LED light source included.
- Equipped with double cable gland for electrical connection.





| OUTDOOR | Pole Lights |

STICK

This versatile pole light family, adjustable up to 3 meters, is designed to enhance and guide through outdoor spaces. Its multi-axis adjustments and capacity for multiple 'Stick heads' ensure well-lit pathways, making it a perfect tool for illuminating and defining the functions of various areas. Easy to install in gardens, terraces, and more, it suits both tranquil and social settings. With mounting options for walls, ceilings, and floors, it offers a complete and adaptable lighting solution.

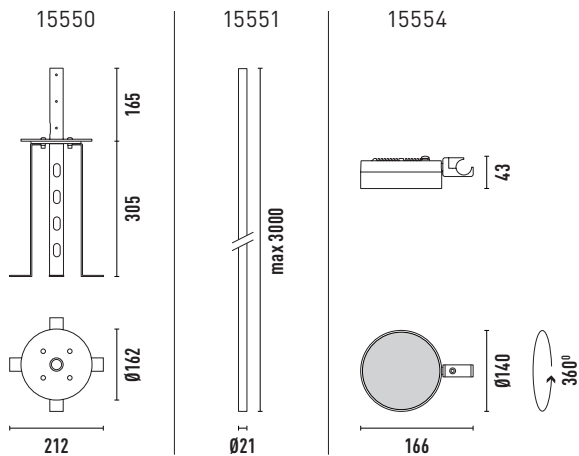

W	°K	Lm	Optics	CRI	Protection
10	3000	694	36°	≥90	IP65

CARTON

dim. L49.5*W26.5*H27cm (15550)

L305*W22*H16.5cm (15551)

L64.5*W32*H26.5cm (15554)

cbm 0.035 (15550), 0.111 (15551),
0.055 (15554)

pcs. 1 (15550), 25 (15551), 20 (15554)

net w. 2.4kg (15550), 29.3kg (15551),
12kg (15554)

gross w. 2.9kg (15550), 37.2kg (15551),
13.8kg (15554)

FINISHES / SKU

Black



15550

15551

15554

FEATURES

- Features a movement system enabling a full 360° rotation in one axis.
- Die-cast aluminum body.
- Base Stick (15550) comes with 2 End Caps.
- Pole Stick (15551) comes with 2 End Caps.
- LED light source included.
- Equipped with double cable gland for electrical connection.





STICK_{short}

This compact version of Stick Family, ideal for pathway and area lighting, brings focused illumination to outdoor spaces. Customizable up to a shorter height, it's specifically designed for floor installation. It effectively lights up walkways and specific areas, enhancing safety and ambiance. Easy to install, it's perfectly suited for lighting up gardens and open spaces with its targeted and efficient illumination.

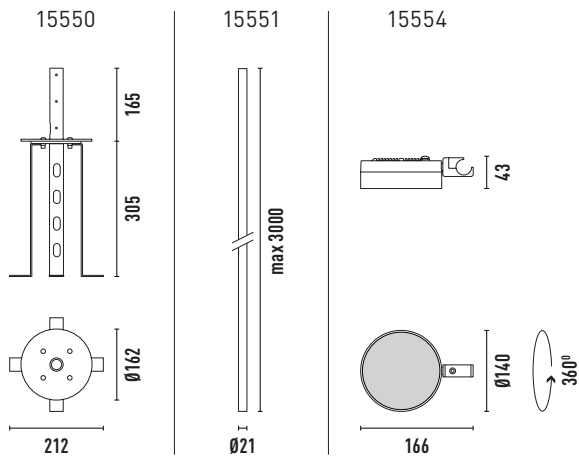

W	°K	Lm	Optics	CRI	Protection
10	3000	694	36°	≥90	IP65

CARTON

dim. L49.5*W26.5*H27cm (15550)

L305*W22*H16.5cm (15551)

L64.5*W32*H26.5cm (15554)

cbm 0.035 (15550), 0.111 (15551),
0.055 (15554)

pcs. 1 (15550), 25 (15551), 20 (15554)

net w. 2.4kg (15550), 29.3kg (15551),
12kg (15554)

gross w. 2.9kg (15550), 37.2kg (15551),
13.8kg (15554)

FINISHES / SKU

Black



15550

15551

15554

FEATURES

- Features a movement system enabling a full 360° rotation in one axis.
- Die-cast aluminum body.
- Base Stick (15550) comes with 2 End Caps.
- Pole Stick (15551) comes with 2 End Caps.
- LED light source included.
- Equipped with double cable gland for electrical connection.





STICK_{wall}

Enhancing the versatile Stick Family, this model includes a specially designed ceiling/wall base, facilitating seamless installation both indoors and outdoors. Ideal for wall and ceiling applications, it provides harmonious lighting to elevate the ambiance of any space, from outdoor patios to indoor corridors. Its adaptable design ensures focused illumination coupled with aesthetic appeal, making it an exemplary choice for a range of lighting scenarios.

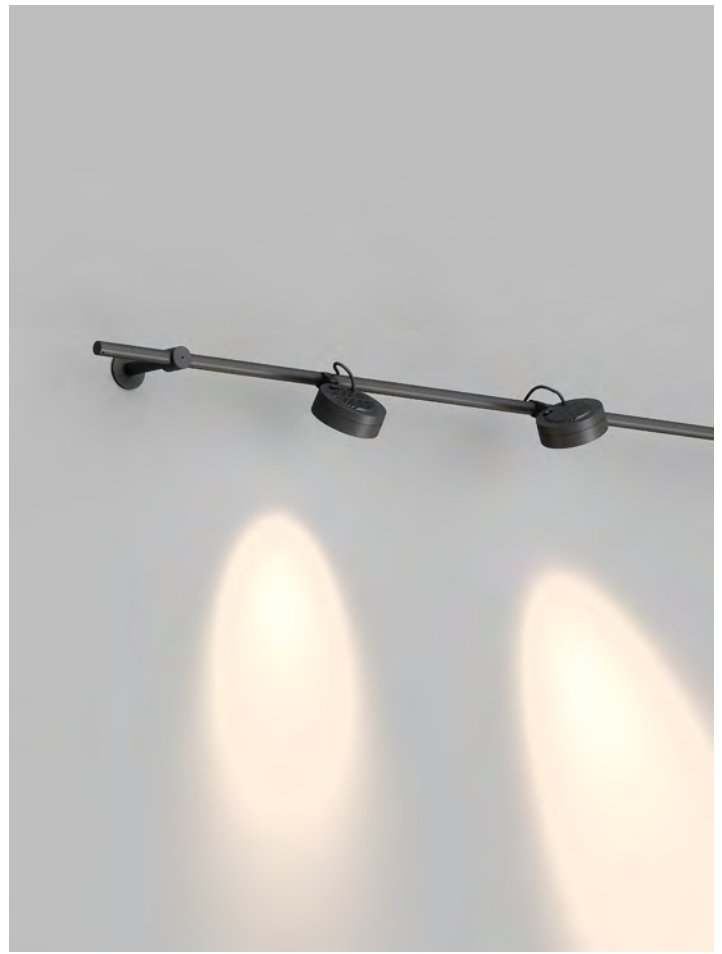
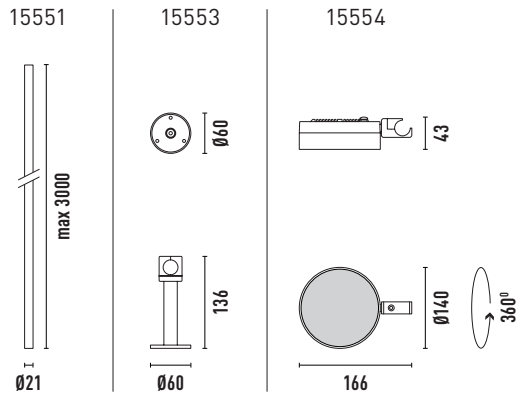

W	°K	Lm	Optics	CRI	Protection
10	3000	694	36°	≥90	IP65

CARTON

dim. L305*W22*H16.5cm (15551)
 L50*W38*H23cm (15553)
 L64.5*W32*H26.5cm (15554)
 cbm 0.111 (15551), 0.044 (15553),
 0.055 (15554)
 pcs. 25 (15551), 30 (15553), 20 (15554)
 net w. 29.3kg (15551), 7.8kg (15553),
 12kg (15554)
 gross w. 37.2kg (15551), 9.8kg (15553),
 13.8kg (15554)

FINISHES / SKU

Black



15551

15553

15554

FEATURES

- Features a movement system enabling a full 360° rotation in one axis.
- Die-cast aluminum body.
- Pole Stick (15551) comes with 2 End Caps.
- Ceiling/Wall Base (15553) comes with 2 End Caps.
- LED light source included.
- Equipped with double cable gland for electrical connection.





FLORA

This inground floor light, designed for illuminating pathways and highlighting architectural and natural elements, epitomizes energy efficiency and superior visual comfort. Its minimized form factor is paired with excellent color quality. Utilizing advanced optics and lenses, it offers a range of light distributions. Highly reliable, it boasts adjustability options and robust resistance to diverse weather conditions and wear.

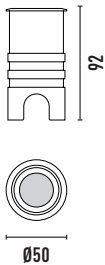

W	°K	Lm	Optics	CRI	Protection
5	3000	151	36°	≥90	IP67

CARTON

dim. L67*W34*H22.5cm
 cbm 0.051
 pcs. 20
 net w. 11.6kg
 gross w. 13.4kg

FINISHES / SKU

Black

 15555

FEATURES

- Die-cast aluminum body.
- LED light source included.
- Equipped with double cable gland for electrical connection.





OUT
DOOR

We Are C-LIGHT

Being a young company, we always focus on the most advanced LED technology.

As all relevant development processes are carried out in house, we can produce custom designs and create new collections followed by the latest trends quickly and flexibly.

DESIGNED in EUROPE MADE in CHINA

C-light factory is located in Zhongshan China. The lowered cost that we achieved is being passed directly on to you.

C-light has been working with European lighting designers to develop custom lights of the highest technical standard. C-light uses the best materials in the market with Hardness Quality Checks for each product. The result is Premium Quality with reasonable price.

HEADQUARTER

Hatnufa 7 St.
9342207 Jerusalem
Israel

LOGISTIC CENTER

Tsela ha-Har St. 47
7178127 Modein
Israel

T +972 (2) 6727811/2

F +972 (2) 6727813

office@clight-led.com
export@clight-led.com

Clight

by **Cabasso Group**